

GEARS
Play guide

Dear player,

Combo is a building kit made with recycled plastic in a small workshop in Brussels.

Colourful, waxy and very strong.
Resistant to water, UV, food and bacteria.
100 years of shelf life. No sharp edges.
Floatable, washable and 100% recyclable.

This play guide gives some ideas for sculptures you can create with a kit. After a bit of mind-stretching, you can go wild with your own creatures, architectures, objects, spinning tops, landscapes or other curiosities.

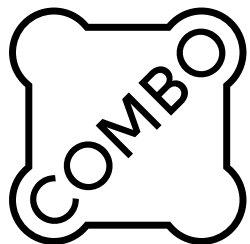

Combining different kits will give you even more building fun and freedom.

Combo is also designed to stimulate other sensory and creative ways of play. With paper and markers, each part becomes a contour drawing tool. With a little paint and a roller, they become stamps. Hiding parts in a bag and letting children describe what they feel, will make you smile. Even this play guide can become a colouring book.

Have fun!

Rebecca & David

Spinning tops

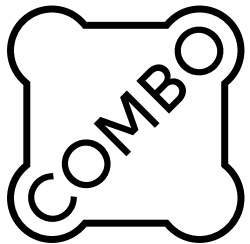
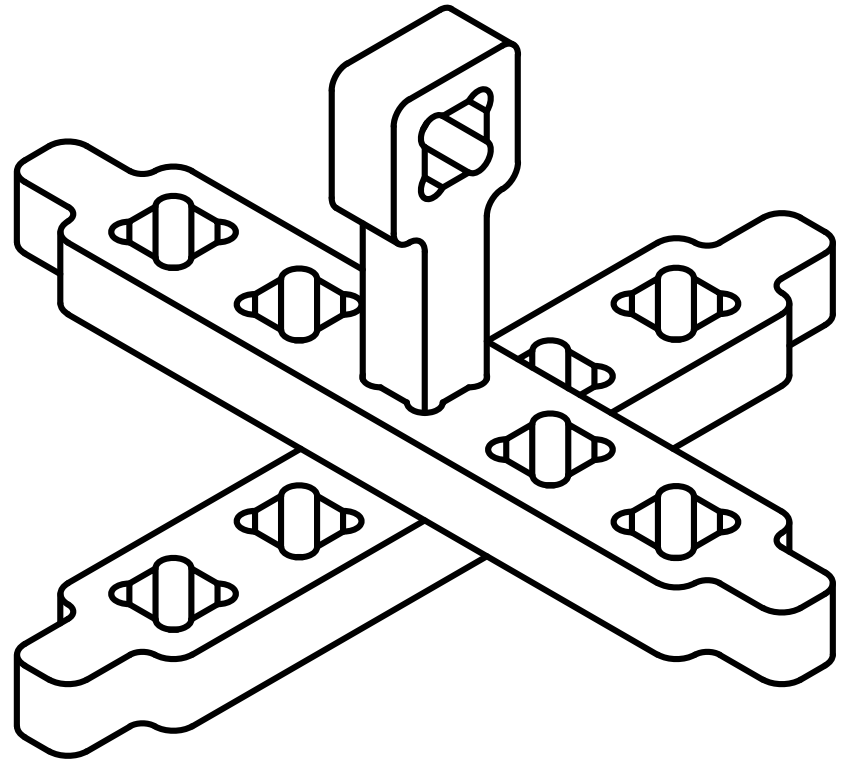
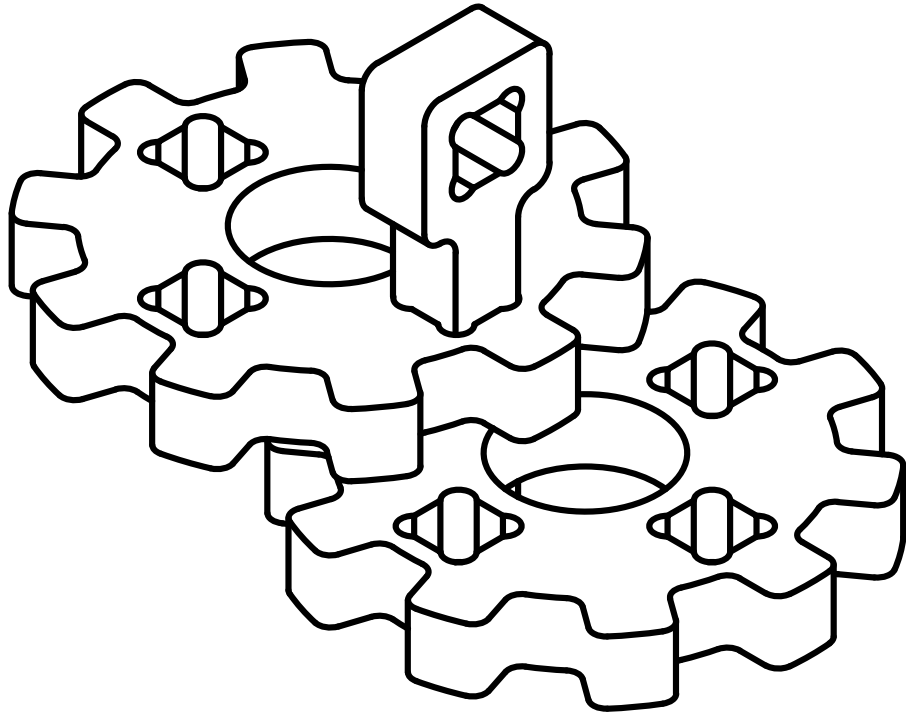

Dragster

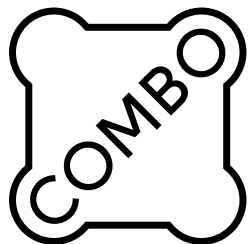
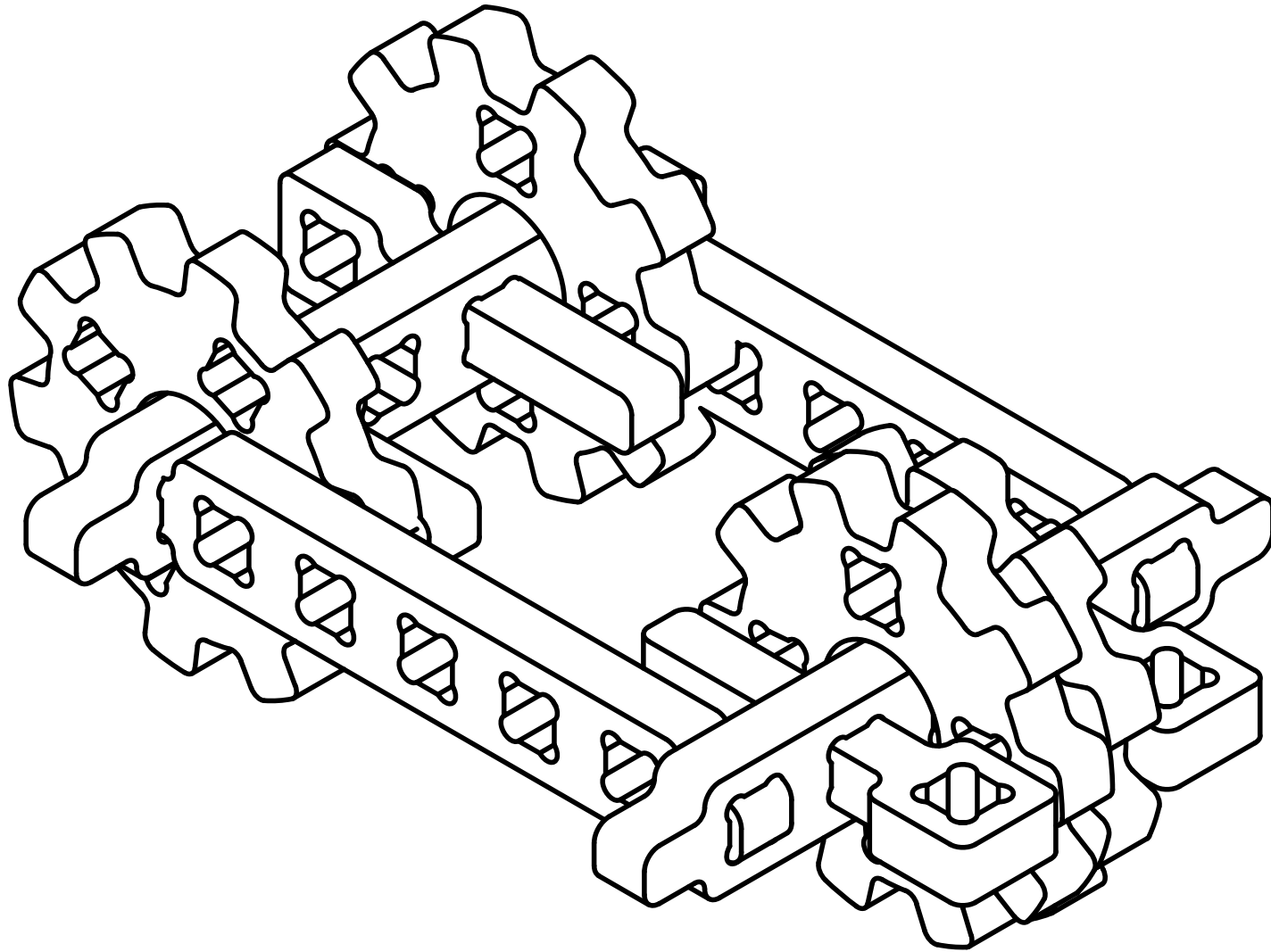

Hot Rod

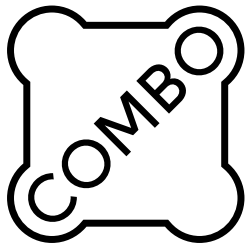
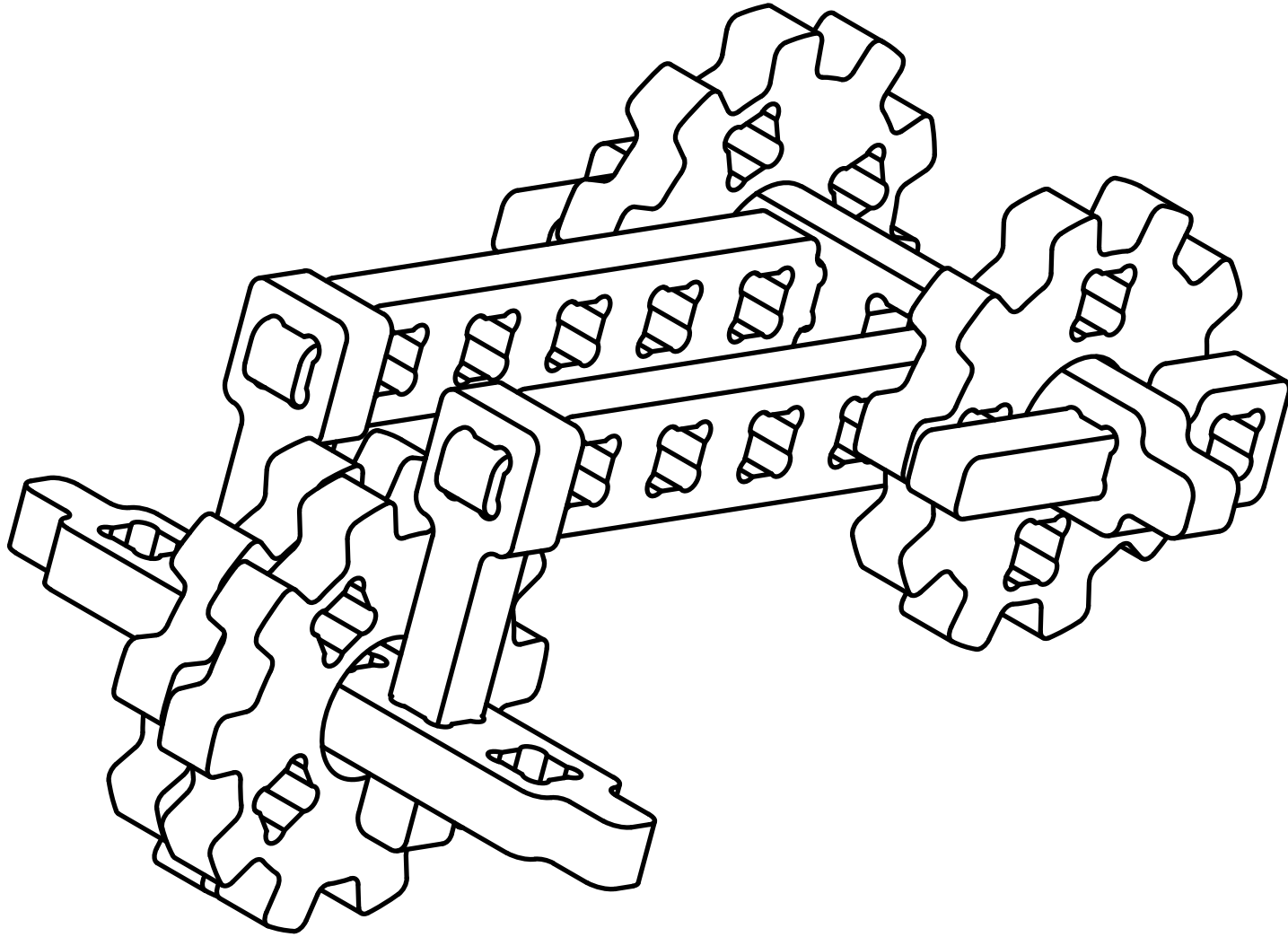

Googles

